

Ronin Lift

PN 2805-11

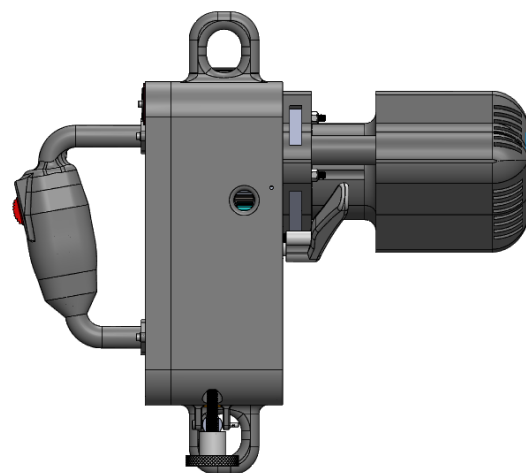

Category	Battery Powered Rope Ascender
Length (L)	11.35 inches
Width (W)	15.39 inches
Height (H)	13.35 inches
Weight	Approximately 24 lbs. (11 Kg)
Construction	Aluminum, Stainless Steel and Bronze
Finish	Powder Coat Black
Operating Temperature Range	-4 °F – 120 °F (-20°C to +49°C)
Ingress Protection (IP)	IP54
Battery Type	28 VDC Lithium Ion Rechargeable
Battery Life Ascent	350 ft.(107m) of rope @ 400lbs. 700 ft.(213m) of rope @ 200lbs.
Battery Re-Charge Time	Approximately 2 hours
Rope Type	11 – 13 mm Aramid or Kernmantle Sheath Static Line Rope
Rope Loading	End Feed
Ascent Speed	Variable (0.5 – 1.5 ft./per second)
Descent Method	Gravity Feed with manual brake
Descent Speed	3.5 ft./sec. max @ 400 lbs. (181Kg)
Secondary Safety	Secondary Lock Out Feature (Hands Free)
Max Working Load	400 lbs. (181 Kg)
Product Certifications	CE Certified & ANSI Certified
Reverse Functionality	For Angled Ascents, winching applications, removing rope from the system.

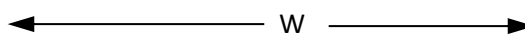
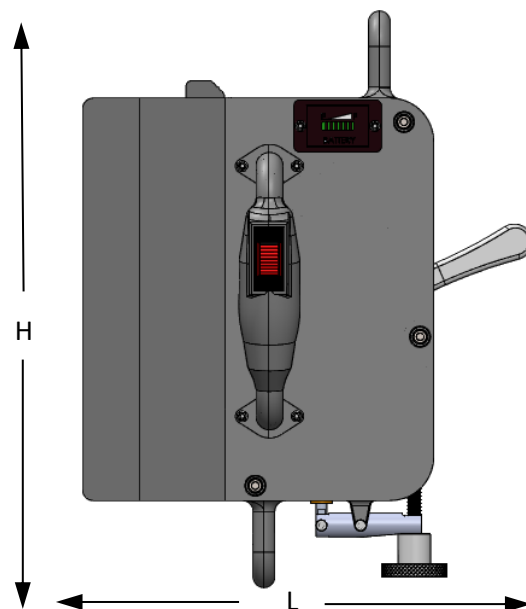

Features

- Lightweight & portable
- Rugged and durable construction
- 400 lbs. (181Kg) continuous lifting capacity
- Thumb wheel trigger for variable speed control
- Automatic braking feature for hands free work
- Hot swappable battery pack for continuous use
- Integrates with existing climbing technology
- CE and ANSI Certified
- Can act as both a winch and ascender

Applications

- Gear Hauling / Winching
- Rope Ascending
- Oil & Gas
- Search & Rescue
- Confined Space Extraction
- Tower / Power Electric
- Concert / Stage Rigging
- Arborist
- Wind Turbine & Many More